

PBF5X7-X: PUSH BUTTON FRAME, 5" x 7"

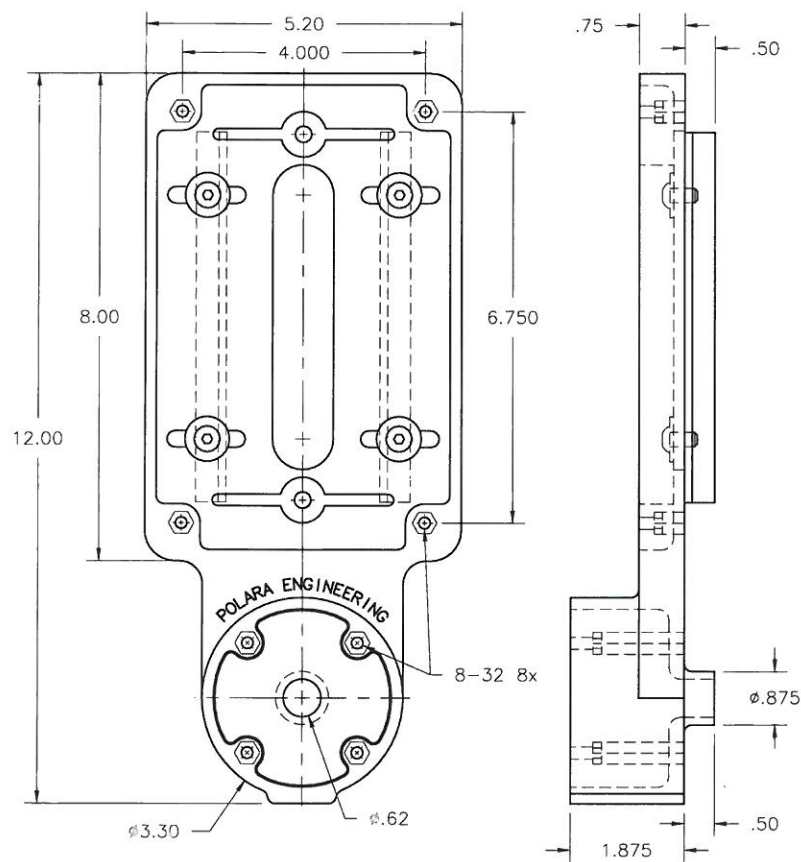

Polara Engineering's Push Button Frames are designed to mount on a 2½" diameter pole up to a 24" diameter pole, or a flat surface. Their cast aluminum structure and powder coated finish provides a very strong and attractive mount for a pedestrian push button and sign.

Polara's frame is unique from other companies frames in that other companies typically drill and tap holes directly into the aluminum of the frame. When a dissimilar metal screw is installed to hold the button or sign, bi-metal corrosion occurs between the screw and aluminum. When the screws need to be removed they often break or strip out the threads. This renders the frame useless requiring a new frame to be installed, or significant time must be spent drilling and installing inserts or tapping new holes.

Polara installs high quality stainless steel helicoils that, when used with stainless steel screws, eliminate the bi-metal corrosion problem.

To designate color replace "X" in part number with:

- "B" for Black
- "G" for Green
- "Y" for Yellow

Material: Aluminum