

EZCommunicator 4 Wire Navigator APS System Installation Manual

System Installation

Please read Operation Manual for description of products, functions and settings.
Please read this Installation Manual completely before beginning an installation.

OVERVIEW

Installation involves installing the PHCU4W in the Pedestrian Signal Head (ped head) and the EZCommunicator Push Button Stations (EPBS) on the pole. A 4 wire cable (Belden 8489 or equivalent) must be routed between each EPBS and its associated PHCU4W. The EPBSs replace any existing pedestrian push buttons mounted on poles, and connect to the push button wires, if available (in addition to the 4 wires from the PHCU4W). Note: Each EPBS is not supplied with a four conductor cable. The wire from the PHCU4W to the EPBS cannot be larger than #18 AWG stranded wires. Polara stocks the pre-cut cable in 12 ft. and 25 ft. lengths, and can be purchased from Polara if needed.

If the cable needs to be routed from one pole through underground conduit to another pole (ped head and associated button are not on same pole), the installer must supply the appropriately rated cable for underground applications. Polara recommends Belden 27326A for this use.

To install an eight (8) push button system should take a 2 man crew 8-12 hours (assuming no complications). To install an eight push button system when the ped heads are on the same pole will take a 2 man crew 8 hours or less.

The PHCU4W operates on 120VAC, 60Hz, 6VA. Output to the EPBS is nominally 18VDC, rated for 0.5A maximum, and only provides power and Walk/Don't Walk Status to the EPBS.

Special Notes

E-Navigator Push Button Stations are not designed to be mounted upside down. The gasketing is designed to seal moisture out from the top down. If a Push Button Station is mounted upside down, it will likely fill with water and void the warranty.

To meet new Push Button location requirements, Polara offers products for extending buttons from poles, and adaptor products for mounting two buttons on one pole. Ask your Distributor or see the Mounting Accessories section at www.polara.com.

Installation

INSTALLING PHCU4W CONTROL UNITS

See diagrams/photos later in this manual for typical mounting. If mounting in a ped head, mount PHCU4W in each ped head using the provided mounting brackets and hardware (see pages 5-9).

Refer to the **"WIRING DIAGRAM"** on page 6. Route 4 wire cable between the EPBS and PHCU4W, then connect to output side of PHCU4W. Double check for correct hookups.

Install Push Button Station(s) per below before performing next step.

WARNING: The following WALK and DON'T WALK wiring connections are made to AC line voltage and is dangerous. It is recommended that the intersection be placed in flash or PED signals turned off while connections to these signals are made. Refer to the

Summary of Installation Steps

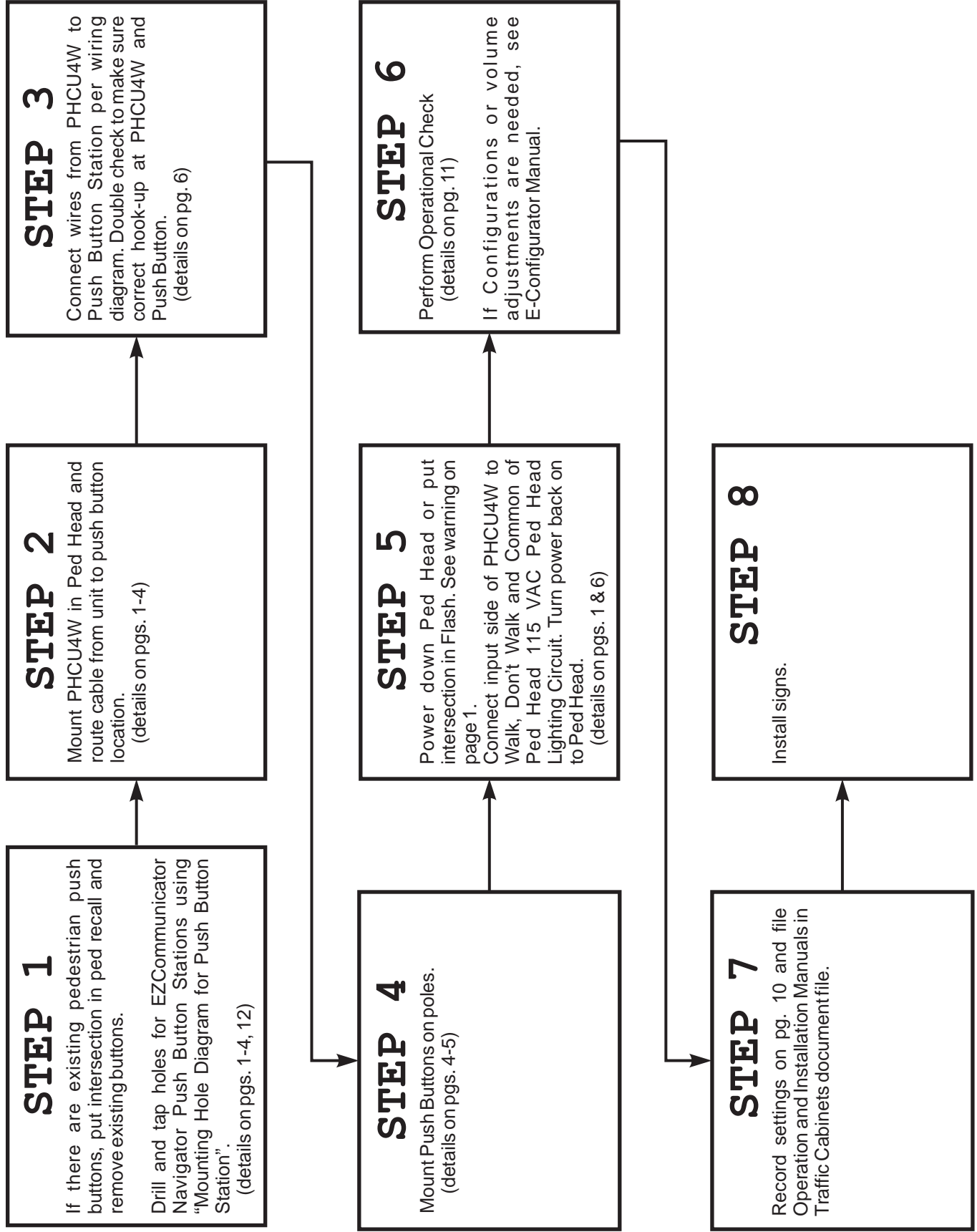

"WIRING DIAGRAM" on page 6 and connect ped sign, Common, Walk, and Don't Walk to input side of PHCU4W (additional ground is optional).

Return the traffic signal controller or ped heads to normal operation.

Test the system for proper operation. Check each EPBS per the **"System Operational Check" on page 11.**

INSTALLING PUSH BUTTON STATIONS ON POLES

It is recommended that the time be set at this time to allow for the fault reporting to have a valid timestamp. See the Operation Manual for more information.

Determine if EZCommunicator Navigator EPBSs have special messages. If the messages are provided by Polara, there will be a label on the back with the street names. Determine location for each per the street being crossed.

If custom voice messages need to be programmed, it is recommended that they are programmed during the system configuration in the shop before installation in the field. However, if units are to be programmed in the field, a laptop with the proper software and voice messages must be prepared prior to installation on the intersection. See the **"Preparing Custom Voice Messages"** instruction sheet in the Support section at www.polara.com for more information.

Note: If a system is installed while it is raining, you must keep water from getting inside the Push Button Stations. Warranty is void due to failures caused by internal water damage. If units must be opened to change the arrow direction, we recommend this be done indoors prior to installation.

The recommended button height from the ground to the center of the push button is 48" maximum. It can be lower, but should not be higher.

Note: The visually impaired use the face of the push button station and the arrow on the button to determine the direction of travel. The arrow should point across the street in the direction of travel and, when mounted, the sign of the EPBS should be parallel with the crosswalk. To ensure proper mounting orientation, place the outside of your forearm against the sign with your fingers straight. Your arm should be parallel to the crosswalk and point to where the crosswalk ends across the street. If your arm does not point to where the crosswalk ends, remount the EPBS so it does. If you are mounting an EPBS to a fluted pole, Polara offers a mounting plate that helps achieve parallel mounting. Contact our sales department for more information.

Remove the sign from each EPBS by removing the 4 screws holding the sign. Remove the bottom cover by removing the two screws on the bottom of the unit. If the arrow direction is correct, there is no need to remove the main cover. If the arrow needs to be rotated, remove the 9 screws holding the main cover. A Security Torx screwdriver bit is required for two of the screws. Keep the main cover away from metal pole or other metal objects; the magnet may pull the diaphragm assembly out and possibly damage it if it comes too close to other metal objects. Place the main cover on a flat surface with the backside facing you. To change the arrow direction, loosen the 4 screws that hold it 1-2 turns, then slowly press on the front of the button and turn the button diaphragm counter-clockwise. The button diaphragm assembly should pop out. Orient the arrow in the proper direction. Place the diaphragm so each tab goes under the screw head and into its pocket, then tighten the 4 screws. The screws must not pinch and bind the diaphragm to the cover inhibiting its movement. Reinstall main cover and 9 screws.

For brand new installations where mounting and wire holes do not pre-exist in the poles, determine desired location and button height, then mark the location for two ¼-20 mounting holes for bolting push button to pole. These two holes should be 6" apart. From the bottom hole, measure down 7" and mark for wire hole. Drill and tap the two mounting holes to ¼-20. Drill wire hole to 3/8" minimum. See page 12 for template diagram. Do not drill with the EPBS open near the pole. The magnets on the speaker and button will attract shavings potentially causing problems.

For poles with existing push buttons, if they are frames they often already have the two ¼-20 holes 6" apart and a wire exit hole approximately 3.44" lower. These will work for EPBS installation as long as a minimum of 8" of wire can extend from the wire exit hole.

For poles with existing push buttons mounted on a cup, as long as a minimum of 8" of wire can extend from the wire exit hole, and the height of the Navigator's button does not exceed 48" above the ground, or the local authority's specific height, the EPBS can mount using the existing wire hole. Mark, drill and tap the ¼-20 holes where needed.

If the wires cannot extend 8" from the pole, the EPBS can be raised so the wire hole exits just above the bottom of the EPBS as long as this does not put the center of the button greater than 48" above ground level. If it is greater than 48", a new (lower) wire exit hole and the appropriate 6" spaced ¼-20 holes must be drilled.

Refer to **"Wire Routing Instructions" on page 5** for the optional step of connecting the button wires. Once you have resolved button wire length and hole location issues, tape the two button wires so they are flat, parallel and oriented so they correspond to the +/- terminals on the EPBS. Start taping 1.5" from the end of the wires and tape all the way up to past where the wires will enter the pole so the tape protects the wires from shorting to sharp edges on the wire exit hole.

The unit can be bolted to the pole prior to connecting the wires to the unit. Double check that the wires are the proper length by holding EPBS up to mounting holes in pole and routing wires down the channel on the back of the EPBS. The wires will wrap around the opening in the bottom of the EPBS to the front where they will connect to the terminals on the EPBS. Screw in the two provided ¼-20 bolts and washers in the two locations on the EPBS until the unit is loosely held in place to the pole. Connect the 4 wire cable (installer provided cable, or Polara P/N 850-288-X) and optional button wires to terminals per the wiring diagram on page 6. Press any excess wire into the cavity above terminal block or route the excess wire back into the pole. Make sure the wires are within the guide channel of the EPBS (not pinched between pole and EPBS), then tighten the two bolts until the EPBS is secure on the pole.

If custom voice messages need to be programmed into the unit, download **"Preparing Custom Voice Messages"** instruction sheet from www.polara.com.

Install the bottom cover onto the EPBSs by securing the two screws on the bottom of the unit.

If the EPBS is going to be mounted on a wooden pole, mounting diagrams are available for download at www.polara.com. You can also contact Polara for more information at (888) 340-4872.

Wire Routing Instructions

Make sure button wires going into hole in pole are taped and protected against shorting on sharp edges of hole.

Ensure a minimum of 8" of wire extends from the pole.

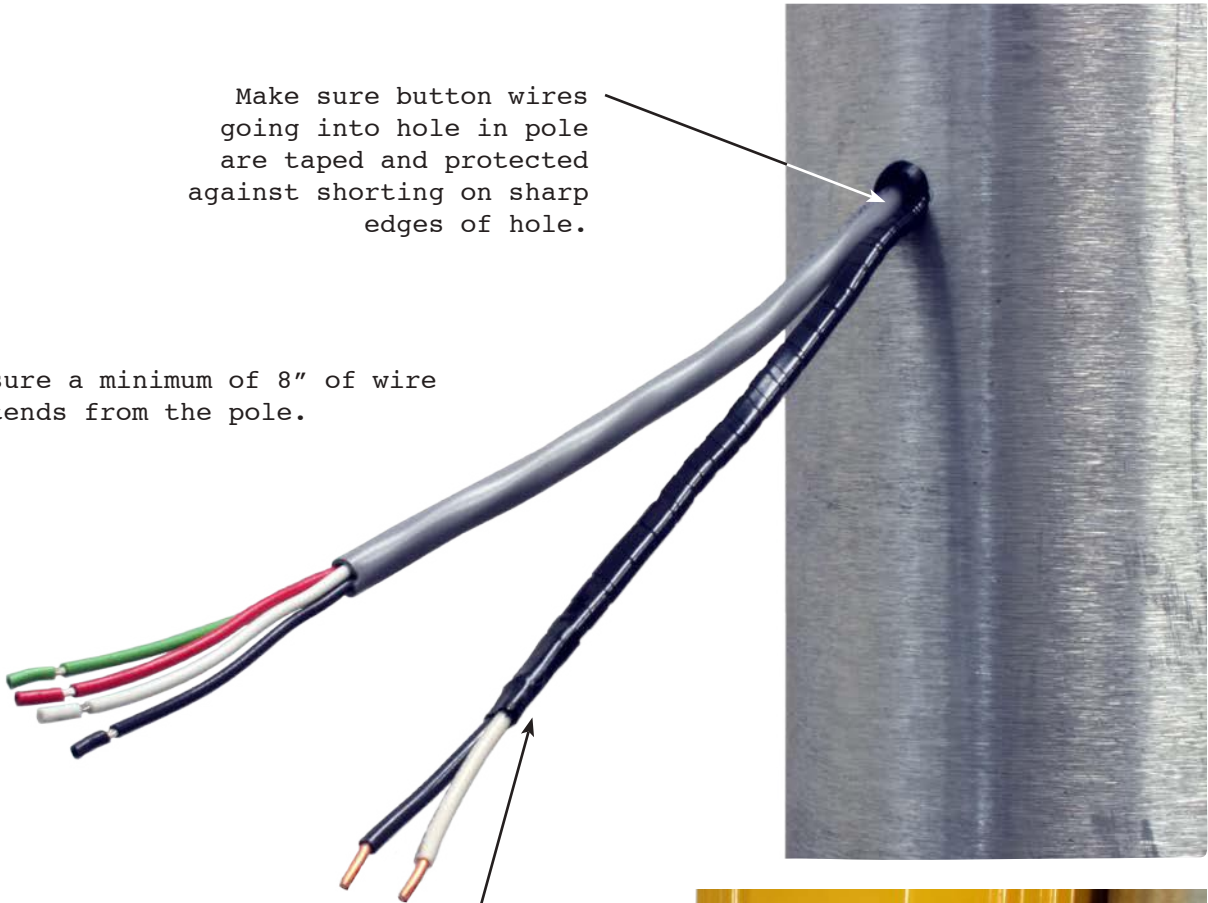

Tape wires parallel starting 1.5" from ends up to and past the wire hole.



Make sure wires are within the guide channel of the casting and not pinched between the pole and casting.



WIRING DIAGRAM

EZCOMMUNICATOR 4 WIRE NAVIGATOR

For control units installed in ped heads, the installer provides these wires. Colors are optional.

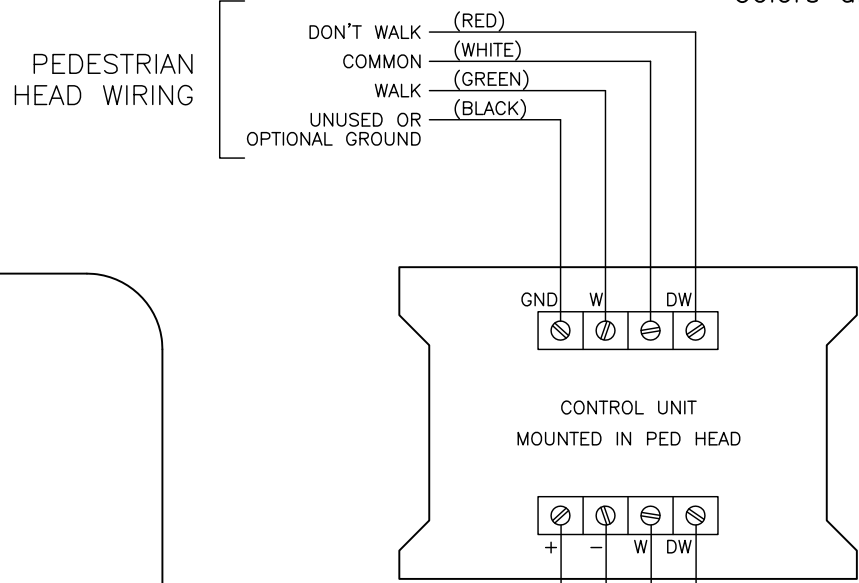

For control units installed in ped heads, P/N 850-288-12 or -25 can be purchased from Polara that have colors shown, or the installer can provide these wires. The same colors are recommended.

* Belden Cables 8489 and 27326A have these colors.

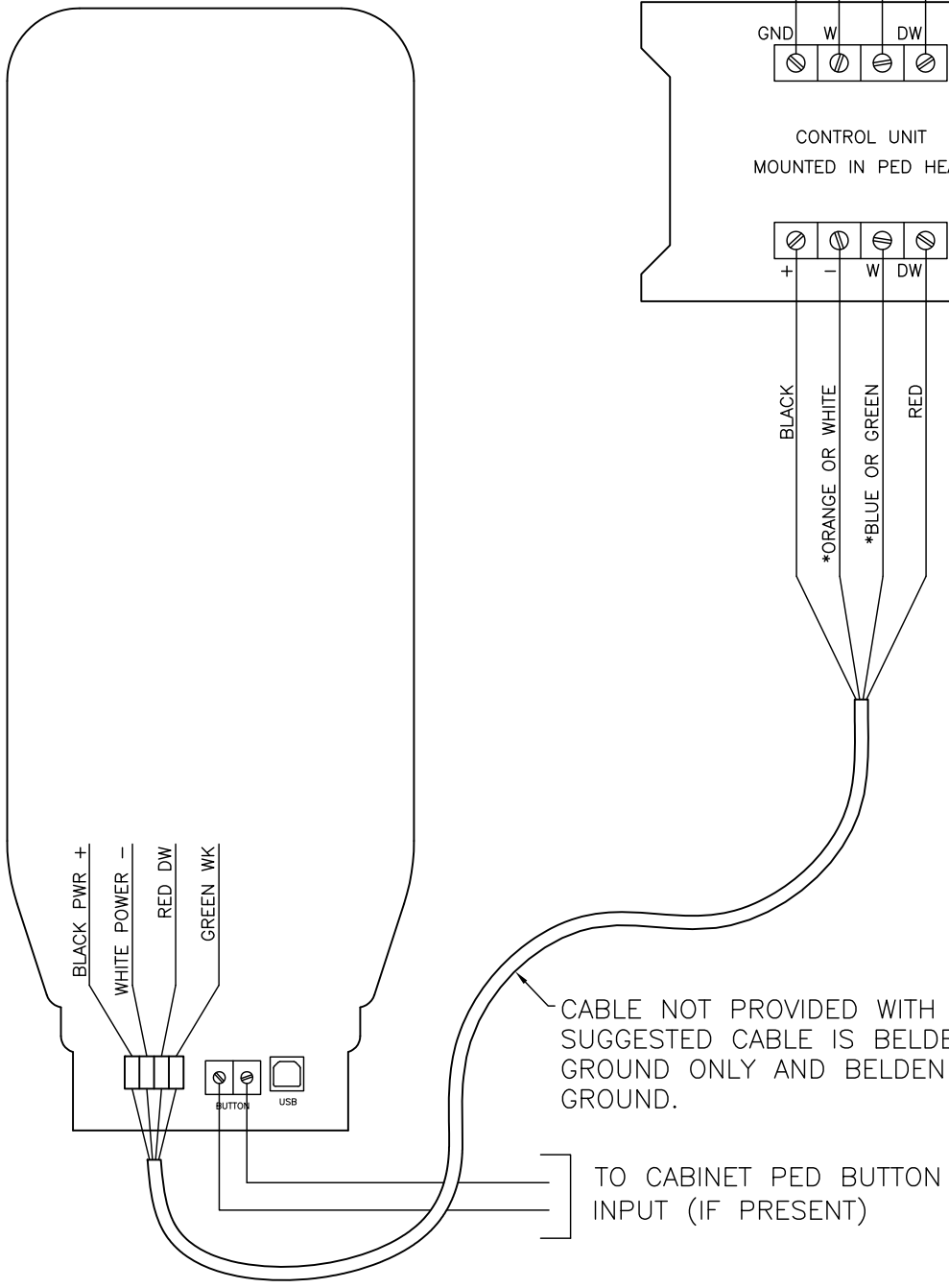

CLAM SHELL HAND/MAN DUAL INCANDESCENT LAMP

MOUNTING
BOLTS

ALL WIRING
NOT SHOWN.

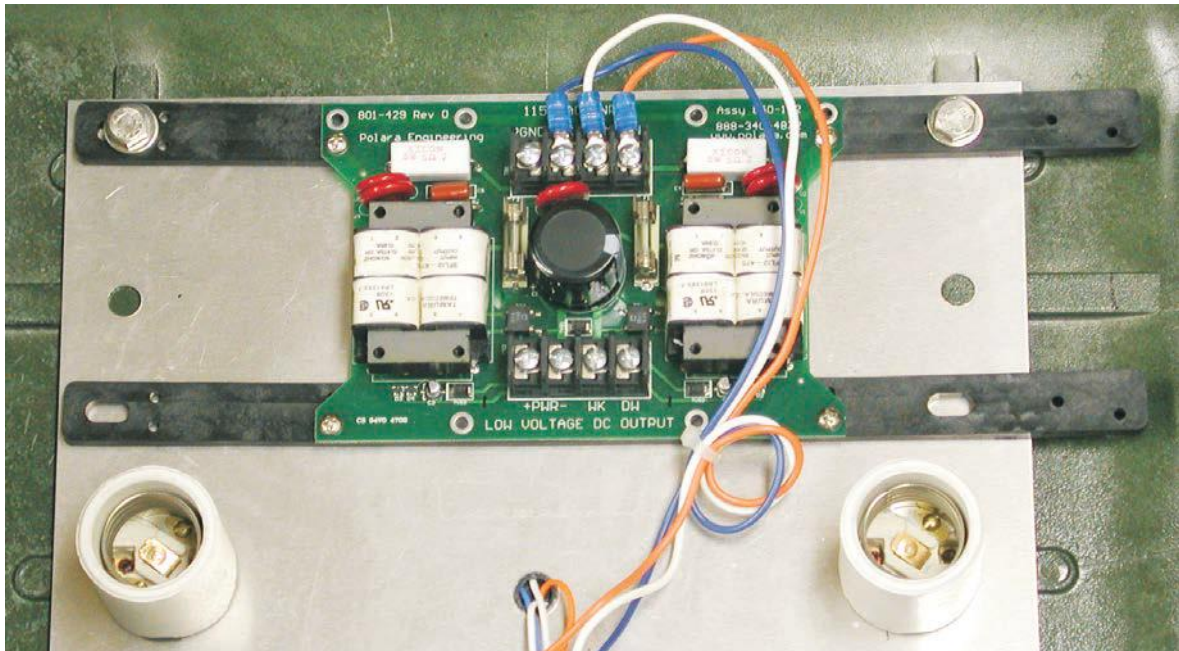
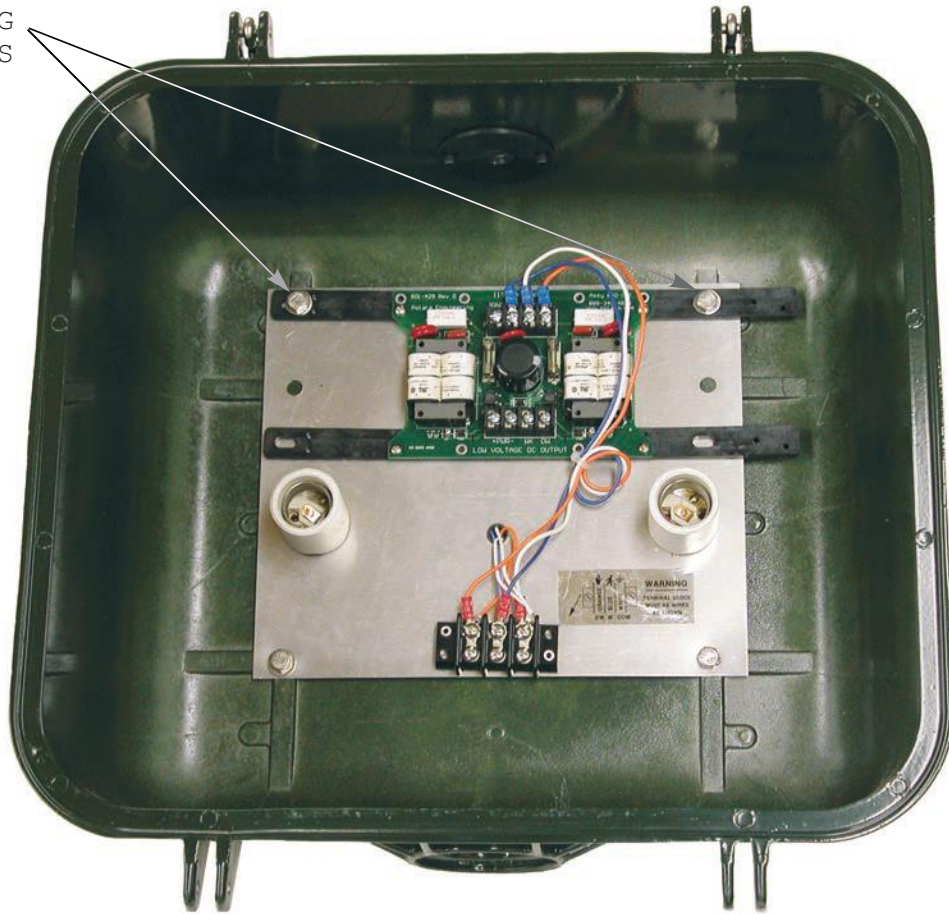

9" x 9" OVER/UNDER PED HEAD

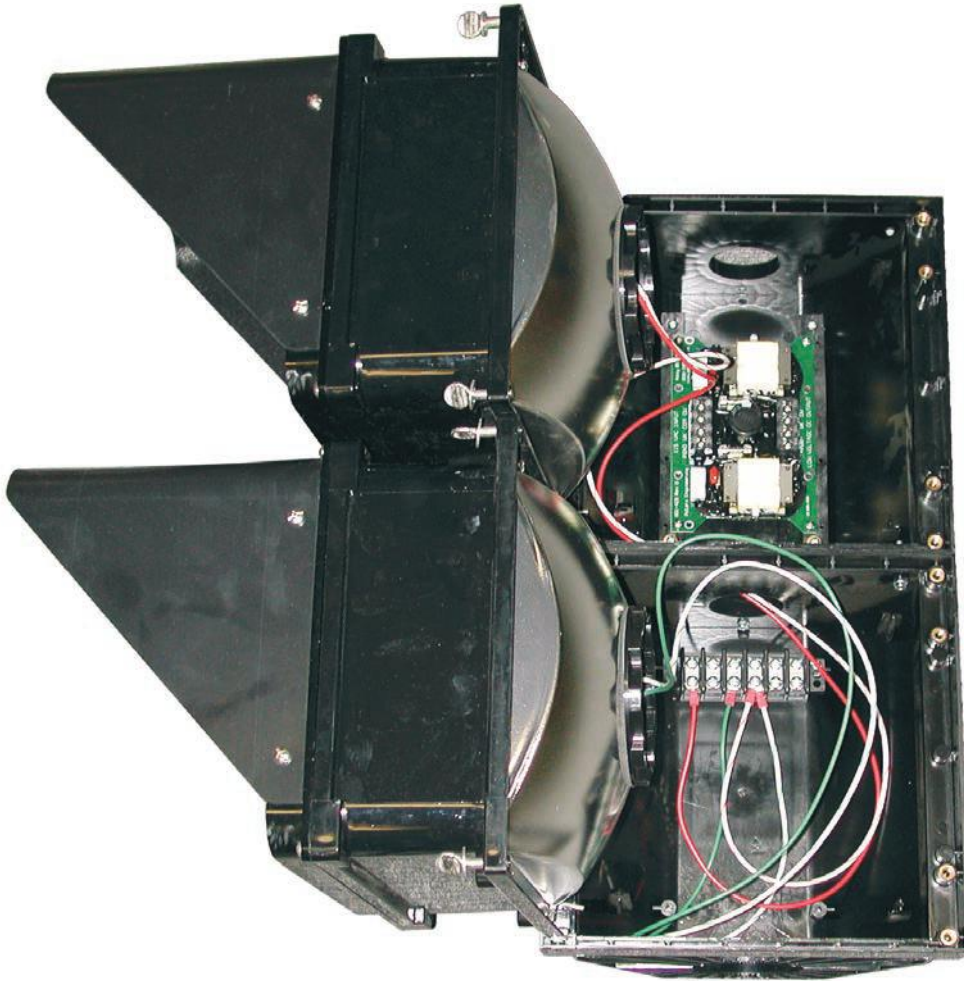

WIRING TO PCB
NOT SHOWN.

CUT BRACKETS AT SNAP
LINE. PCB MOUNTS
TO INSIDE HOLES ON
BRACKETS.

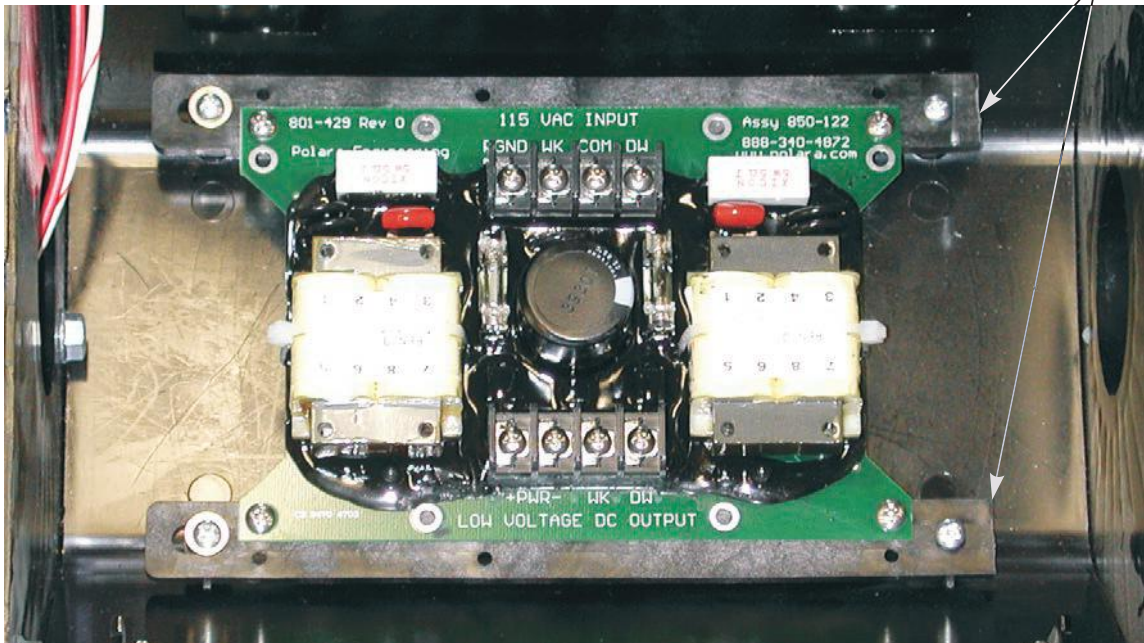

Default and Field Settings

City _____ State/Province _____ Install Date _____

Intersection: _____

Street: _____

Corner: _____

ID: _____

Phase: _____

Defaults

LOCATE VOL MIN	0%	_____	_____	_____	_____	_____	_____
LOCATE VOL MAX	50%	_____	_____	_____	_____	_____	_____
INFO MSG VOL MIN	65%	_____	_____	_____	_____	_____	_____
STD WALK VOL MIN	30%	_____	_____	_____	_____	_____	_____
STD WALK VOL MAX	60%	_____	_____	_____	_____	_____	_____
EXT WALK VOL MIN	60%	_____	_____	_____	_____	_____	_____
EXT WALK VOL MAX	80%	_____	_____	_____	_____	_____	_____
VOL OVER AMBIENT	0 dB	_____	_____	_____	_____	_____	_____
LOC VOL OVER AMBIENT	0 dB	_____	_____	_____	_____	_____	_____
WALK MODE SOUND	STD MSG	_____	_____	_____	_____	_____	_____
WALK SOUND PAUSE	.5 SEC	_____	_____	_____	_____	_____	_____
WALK SOUND TRIG	ANY PUSH	_____	_____	_____	_____	_____	_____
SOUND/VIB TIMER	20 SEC	_____	_____	_____	_____	_____	_____
SOUND/VIB RETRIG	NEW WALK	_____	_____	_____	_____	_____	_____
CANCEL ON CLEARANCE	YES	_____	_____	_____	_____	_____	_____
CLEAR MODE SOUND	TONE 1	_____	_____	_____	_____	_____	_____
CLEAR TONE PAUSE	1 SEC	_____	_____	_____	_____	_____	_____
LOCATE SOUND	TONE 1	_____	_____	_____	_____	_____	_____
LOCATE TONE TIME	1 SEC	_____	_____	_____	_____	_____	_____
WAIT MESSAGE	OFF	_____	_____	_____	_____	_____	_____
DIRECTION MSG	NORTH	_____	_____	_____	_____	_____	_____
INFO MESSAGE	NONE	_____	_____	_____	_____	_____	_____
PUSH CONFIRM MESSAGE	WAIT	_____	_____	_____	_____	_____	_____
CANCEL ON WALK	YES	_____	_____	_____	_____	_____	_____
EXT PUSH TIME	1 SEC	_____	_____	_____	_____	_____	_____
SECOND LANGUAGE	NO	_____	_____	_____	_____	_____	_____
WALK PING PONG	OFF	_____	_____	_____	_____	_____	_____
CLEAR PING PONG	OFF	_____	_____	_____	_____	_____	_____

Special Notes: _____

System Operational Check

Following installation and power up of units, check the following:

1. When first powered up, the red LED above the push button should flash rapidly for about 5 seconds. This is a power-on self-test of the Ped Station Monitor function and it verifies that this feature is working properly. About 2 seconds later, the locate tone should start playing. If the EPBS is powered on while the walk sign is on, the PSM self-test will not occur.
2. Push each EPBS button and verify that the red LED above the push button turns on with the first push, and that an audible sound is heard for each push. If button wires to the traffic controller exist, verify that the PED call is transmitted to the traffic signal controller.
3. Following a button push, verify that a walk sound is heard and the push button vibrates during the next walk cycle.
4. Confirm the proper sound plays during clearance. If unit is set for countdown, during the first clearance cycle after power up, the unit should be silent. During the second or later cycle, the pole unit should play a voice countdown of the seconds remaining to end of clearance.
5. Proceed to Configuration in Operations Manual. Once all units are configured as desired, recheck each unit for a full cycle to ensure all options and features operate as desired.

When you are satisfied that all units are working properly, install sign on each EPBS.

Evaluate sound levels and responsiveness to ambient noise.

Using the E-Configurator or the software USB interface, make any volume adjustments as needed to each EPBS.

MOUNTING HOLE DIAGRAM FOR PUSH BUTTON STATION

When printing this page in Adobe Acrobat, be sure that "None" is selected in Print Scaling in the printing dialog box to ensure that document is printed to the correct scale. Otherwise, recreate template using dimensions shown.

